

# Trends in Mechatronic Engineering and Education

Patri K. Venuvinod

Professor(Chair) of Manufacturing Eng.

City University of Hong Kong

and

P. Narasimha Reddy

Professor and Principal,

Srinidhi Institute of Science and Technology, A.P., India

# **The pace of innovation is increasing dramatically owing to developments in**

- Communications
- Computerization,
- The Internet, etc.,
- Globalization of markets
- Global distribution of the processes of new product realization (concept development, design, prototyping, manufacture, and servicing).

# Innovation can become the force that could

“liberate humanity in general from the preventable evil called poverty [von Braun '97].”

We cannot ignore the onward march of technological innovation.

# P→Q→I Competitive Strategies

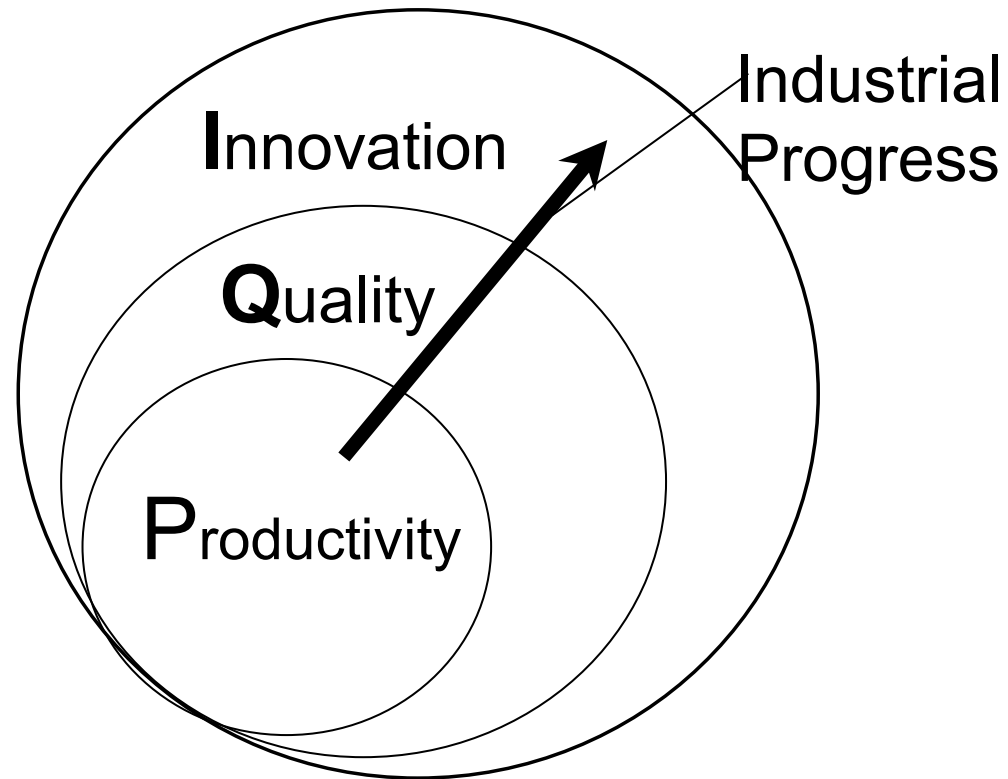

- **Productivity**  
= Functional output/Input:  
→ Satisfy customer needs
- **Quality**  
→ Satisfy customer wants
- **Innovation** → Excite the customer through new ways of delivering value.

$$\text{Value} = \text{Worth} / \text{Cost}$$

### **Productivity**

Reduce denominator through process innovations and using the *corporate left brain*.

### **Quality**

Increase numerator through process innovations using the *corporate heart*.

### **Innovation**

Increase numerator through product innovations and using the *corporate right brain*.

# Trends in mechatronic engineering

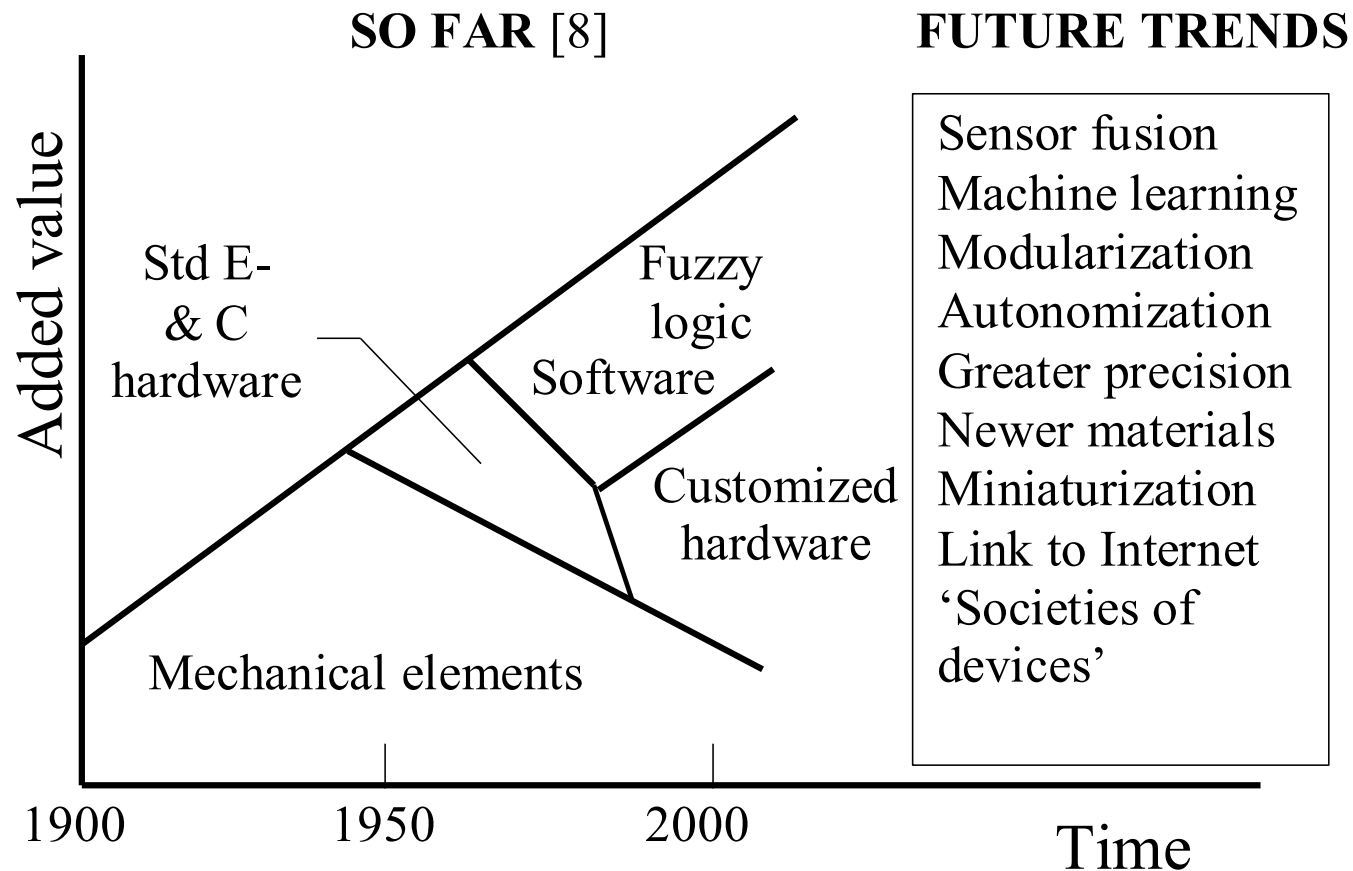

# Classical and mechatronic speed control

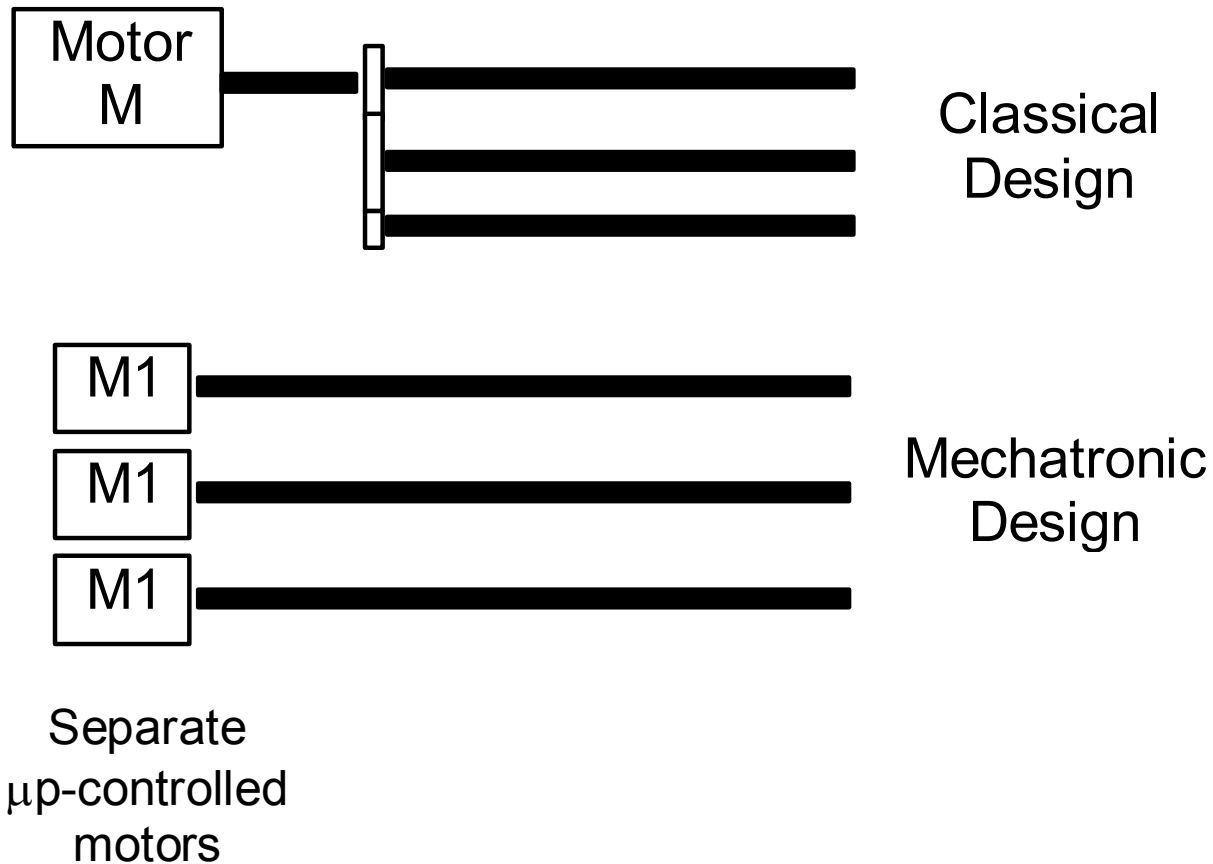



# Some types of mechatronic products

## **TYPE**

- **Transducers and measuring instrumentation**
- **Processing machines**
- **Industrial handlers**
- **Drive mechanisms**
- **Interface devices**

## **EXAMPLES**

- **Ultrasonic receiver, Electronic scale**
- **Turning and machining centers, Bonding machines, Robots**
- **Robots, Component insertion machines**
- **CD players, Printers, Disk drives**
- **Keyboards**

# Benefits of mechatronic engineering

## BENEFIT

- Faster response time
- Better wear and tear characteristics
- Miniaturization potential
- Easier maintenance and spare part replacement

## EXAMPLES

- Servo-motion controller,  
Camera
- Electronic ignition
- Camcorder
- Washing machine

## **BENEFIT**

- Memory and intelligence capabilities
- Shortened set up time
- Data processing and automation
- User friendliness
- Enhanced accuracy

## **EXAMPLES**

- Programmable sequence controllers
- CNC machines
- CNC machines
- Photocopier
- Electronic calipers

Embedded  
computers  
↓  
New  
Process &  
product  
functionalities

Fuzzy Logic  
+  
ANN  
++  
↓  
Smart Products

# Emergence of Mechatronics

- Japan first recognized the strategic importance of mechatronics as a distinct discipline.
- In 1990, a full PhD project was in Denmark to mechatronic design.
- Australia, Hong Kong, Mainland China, and UK have MTE courses and programs.
- In Singapore, mechatronics is even introduced at the secondary school level.
- In Russia, mechatronics courses are introduced within aeronautic engineering programs.

The proliferation of mechatronic engineering programs in universities worldwide is leading to a deeper understanding of

- the specific nature of mechatronic engineering
- how it could be taught more effectively
- the software tools needed for mechatronic design and its teaching

# What is Mechatronic Engineering?

Mechatronics is “*a synergistic combination of precision mechanical engineering, electronic [read computer] control and systems thinking in the design of products and manufacturing processes [Dinsdale 1989]*”

# What it is NOT mechatronic engineering?

- Mechatronics is
- *“the application of microelectronics in mechanical engineering (MITI, Japan)”*
- *“a combination of mechanical engineering, electronic control and systems engineering in the design of products and processes.”*



# What mechatronic engineering IS and what it IS NOT

$M + E + C \neq \text{Mechatronics}$

$M \cup E \cup C \neq \text{Mechatronics}$

$M \cap E \cap C \neq \text{Mechatronics}$

What Mechatronics IS NOT



$S(M,E,C) \Rightarrow \text{Mechanical Goal}$

What Mechatronics IS

# Essential features of mechatronics

- There must always be a design goal that is mechanical in nature.
- The design solution is invariably a system.
- The aim of mechatronics is to produce a competitive solution NOT any solution.
- Mechatronic design invariably involves tradeoffs between the advantages of alternative M, E, and C solutions (M→E → C)

**What professional roles do  
Mechatronic engineers fulfill?**

**What knowledge and skills  
do they need?**

# The scope of mechatronic engineering

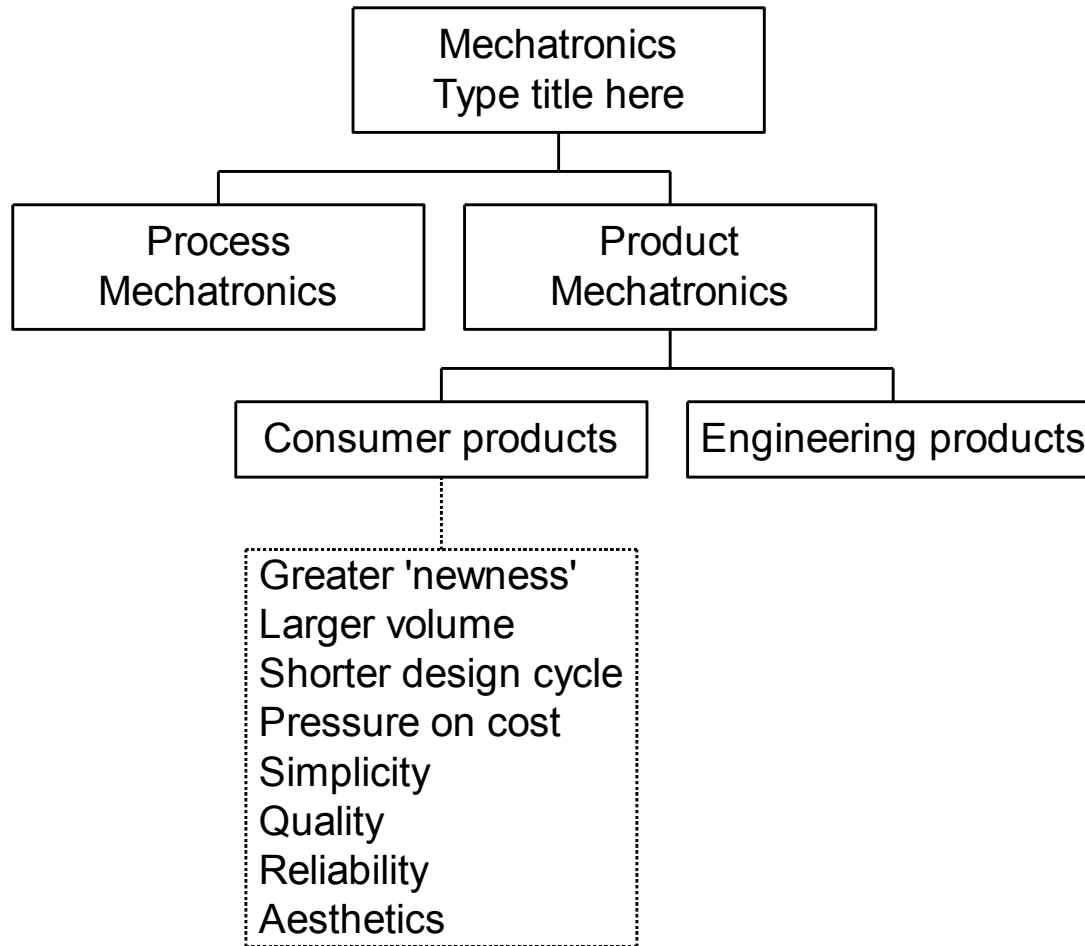

# The Role of Design Management

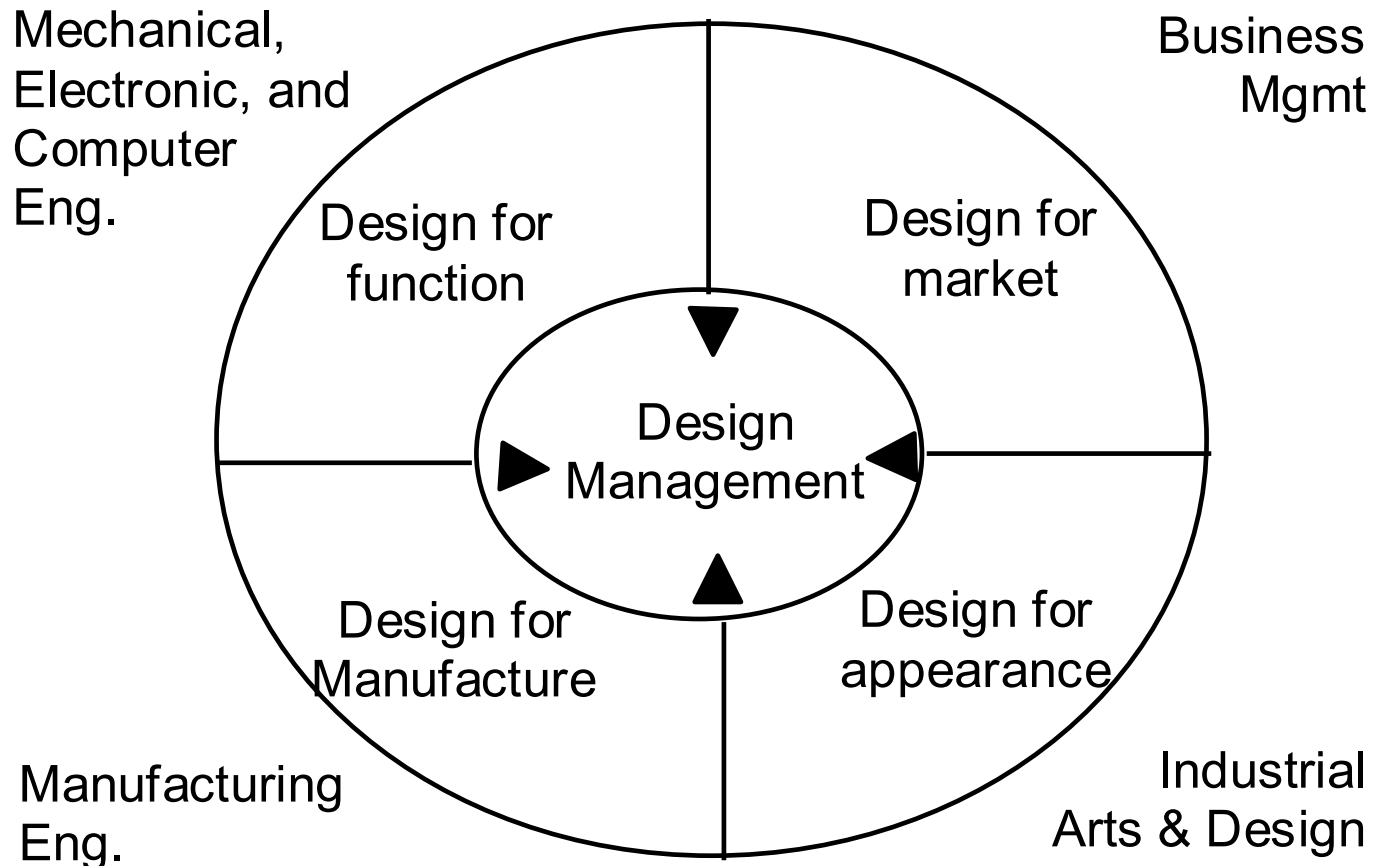

# Contemporary industrial structure

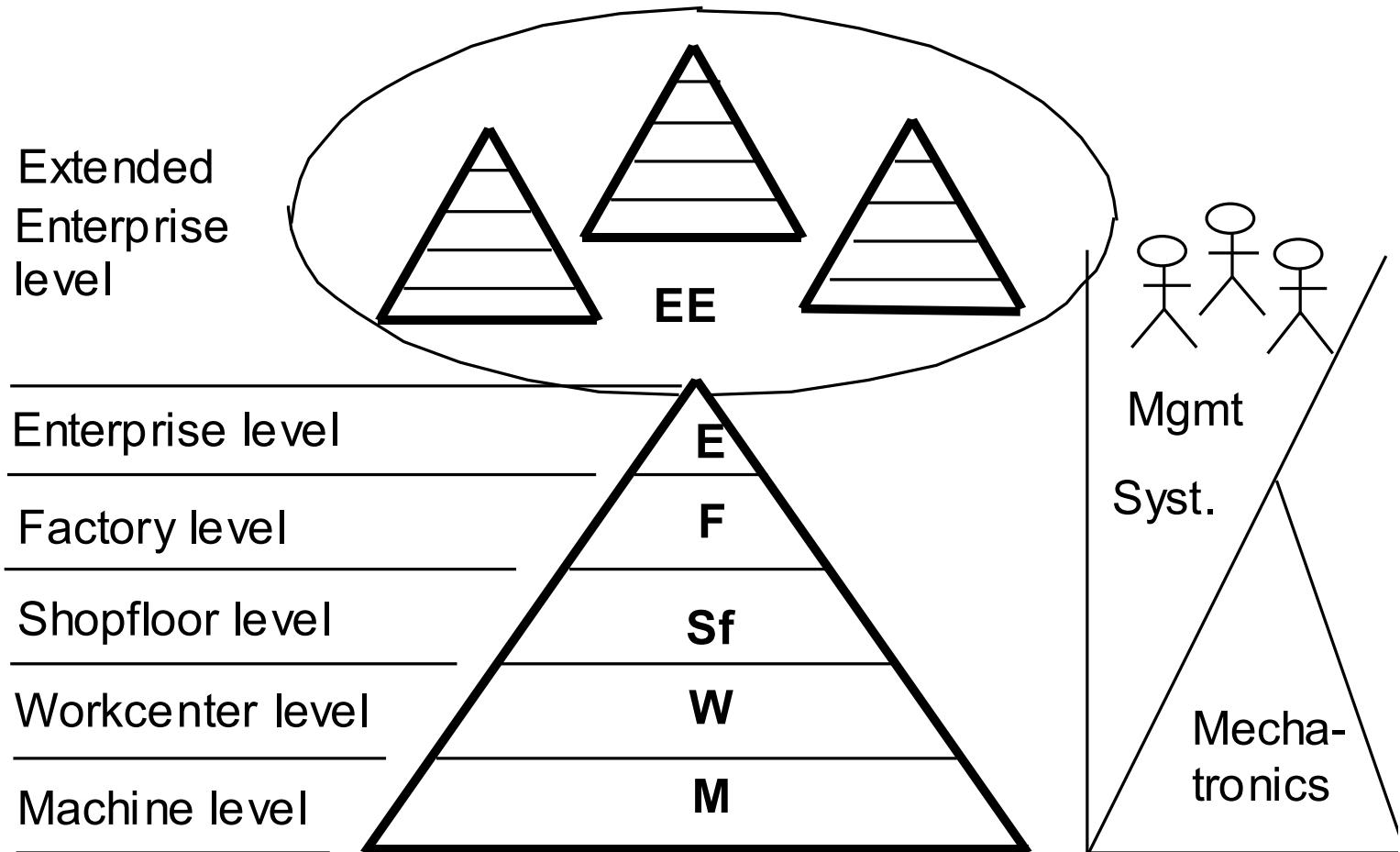

# BEng. Mechatronic Eng. at City U of Hong Kong (2000)

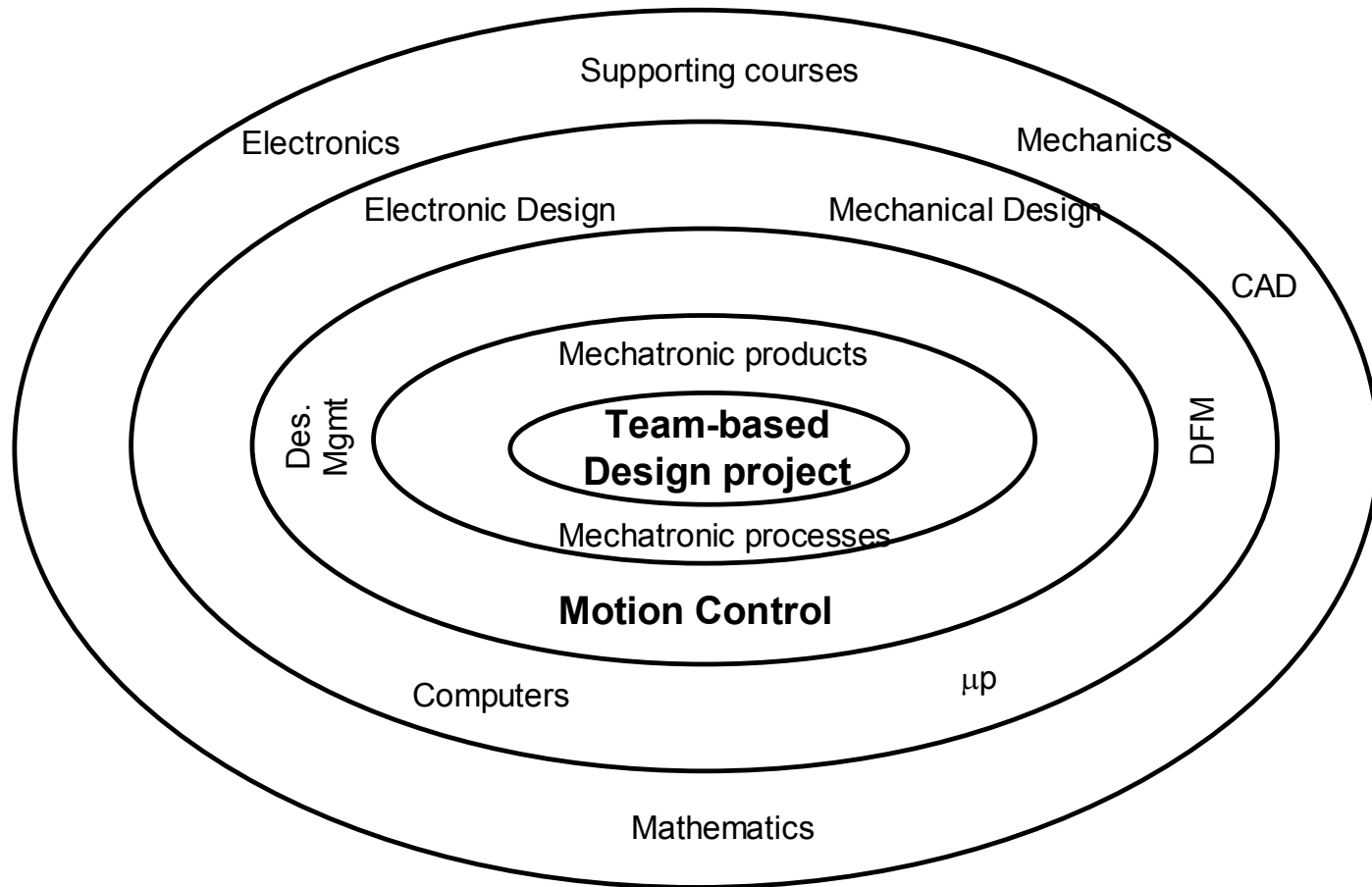

Team-based projects can be used to achieve

- experience-based learning of group goals,
- individual accountability,
- equal opportunities for success,
- team competition,
- task specialization
- adaptation to individual needs



# **Some Design Projects undertaken by groups Of BEng Mechatronic Eng. At City U of HK**

- Smart vacuuming robot
- 4-axis CNC Turn-Mill Center
- Programmable Home Kitchen System
- High Rise Building Window Cleaning Robot
- Intelligent Wheelchair
- Smart Radio Frequency System for  
Supermarket Checkout.

# Future trends in mechatronic engineering

- Sensor fusion
- Machine learning
- Autonomization
- Modularization
- Greater precision
- Newer materials
- Miniaturization
- Link to Internet
- ‘Societies of devices’

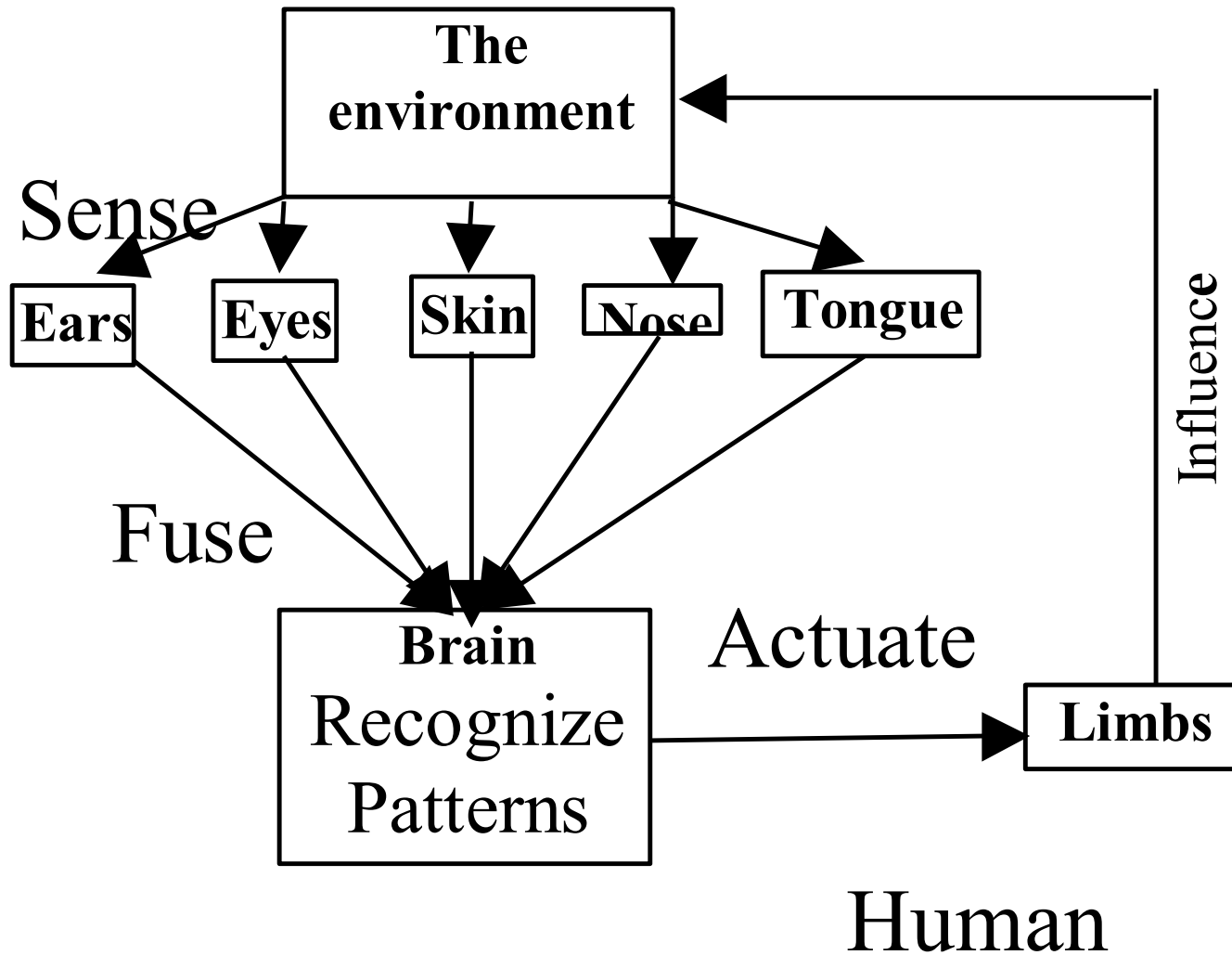

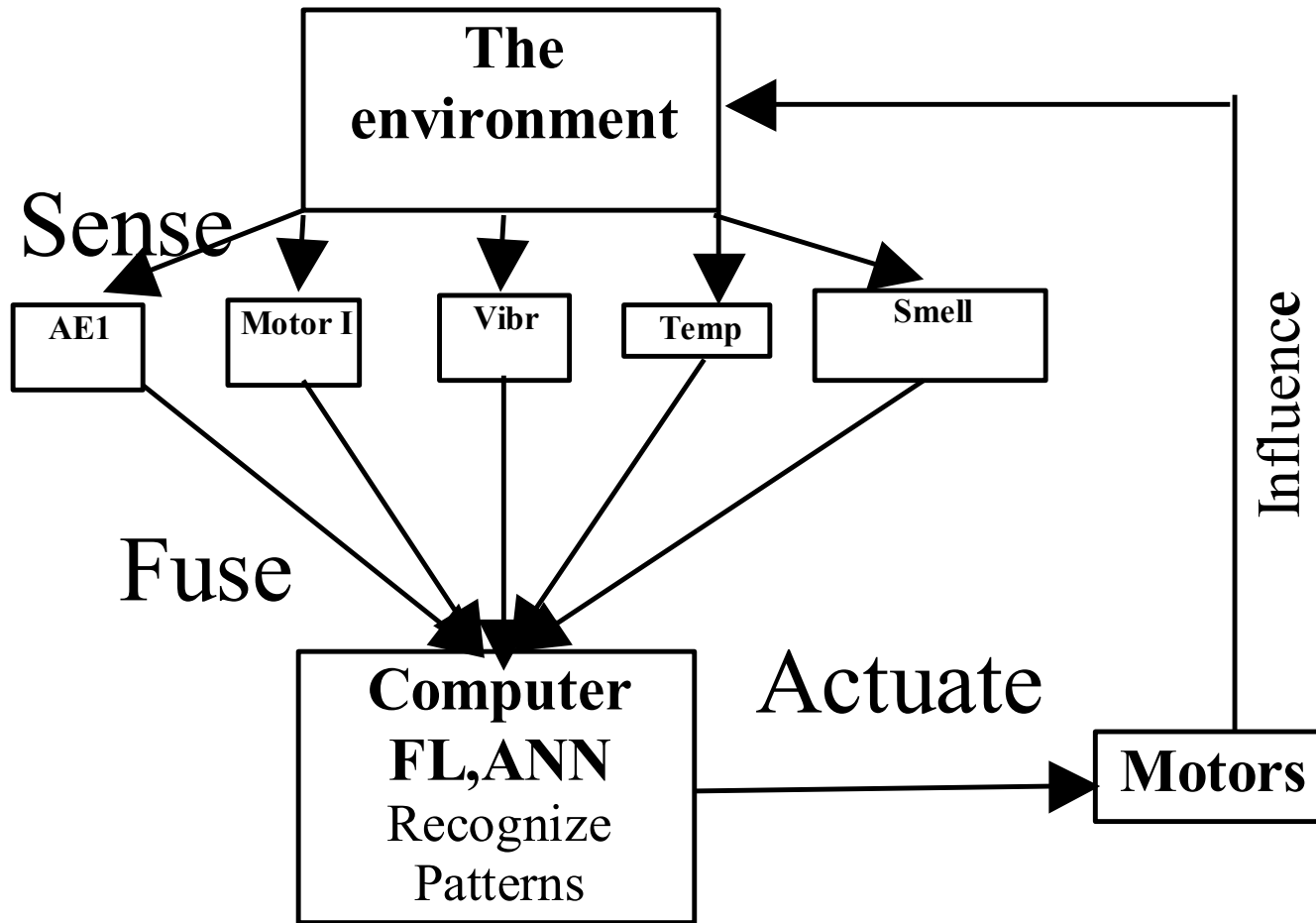

# Mechatronics

## Machine learning:

- Intelligence means adapting to the environment and improving performance over time.
- Learning can be reflexive or reflective.
- ANN and fuzzy logic are tools for learning patterns.

## Autonomization

- The development of the ability to survive and perform robustly while the external environment changes.
- Mechatronic devices will be able to reset their local goals autonomously under changing external environments so as to meet the broad system-level goals set by human beings.

## Modularization

- Will be a consequence of autonomization.
- Mechatronic sub-units will encapsulate all the abilities required for local goal setting, control, and learning.
- The sub-units will be self-contained and intelligent.
- These will appear as black boxes that just need to be selected and interfaced for a specific application.

## Miniaturization

Trend towards mechatronic units of significantly smaller size.

- Precision engineering
- newer materials (composites, diamond coatings, etc.)
- Nano-technologies



## Links to the Internet:

- Mechatronic units will be connected via the Internet to the rest of the world.
- Will be able to access the information and knowledge base available on the Internet so as to optimize its own performance.
- Will be able to communicate its operational status to remote monitors.

(e.g., For instance, one would be able to query from one's office the refrigerator at home about its contents)

## Societies of devices:

- Minsky: “[M]ind is made up of many smaller processes. These we’ll call *agents*. Each mental agent by itself can only do simple things that need no mind or thought at all. Yet when we join these agents and societies—in certain special ways—this leads to true intelligence.”
- Via the Internet, mechatronic devices will join ‘societies’ of devices with a common purpose or interest.

Societies where mechatronic engineering educators can keep up will see quicker economic progress.

What could we in Andhra Pradesh do?